

City of
Gainesville

Lot Size Reform

LD24-000032

LD24-000028

**Department of Sustainable
Development**



Presentation Outline

01

History of Zoning

A brief evolution of single-family zoning in Gainesville

02

Housing Challenges

Gainesville's issues and best practices

03

Lot Size Reform

Overview of the request to allow smaller lots

04

Data & Analysis

Applicability of changes and map of affected properties

05

Public Participation

Workshops, inquiries, and mythbusting

06

Conclusion

Sustainable Development's Recommendation

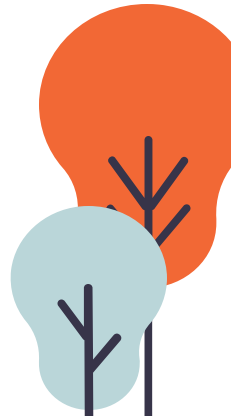

01

History of Single-Family Zoning

Like many cities, Gainesville began as a small town. Today, Gainesville is home to over 150,000 residents and counting. How has zoning evolved over the years to match our growing population and changing society?



Gainesville City Limits – 1905

1931

The Beginning of Zoning

- Florida Legislature creates zoning authority for cities

1932

Gainesville's 1st Zoning Code

- No lot size requirements
- 4-Family Dwellings Allowed
- No familial requirements for "families"

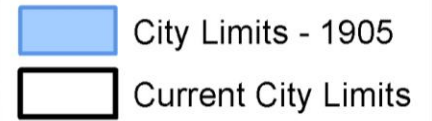
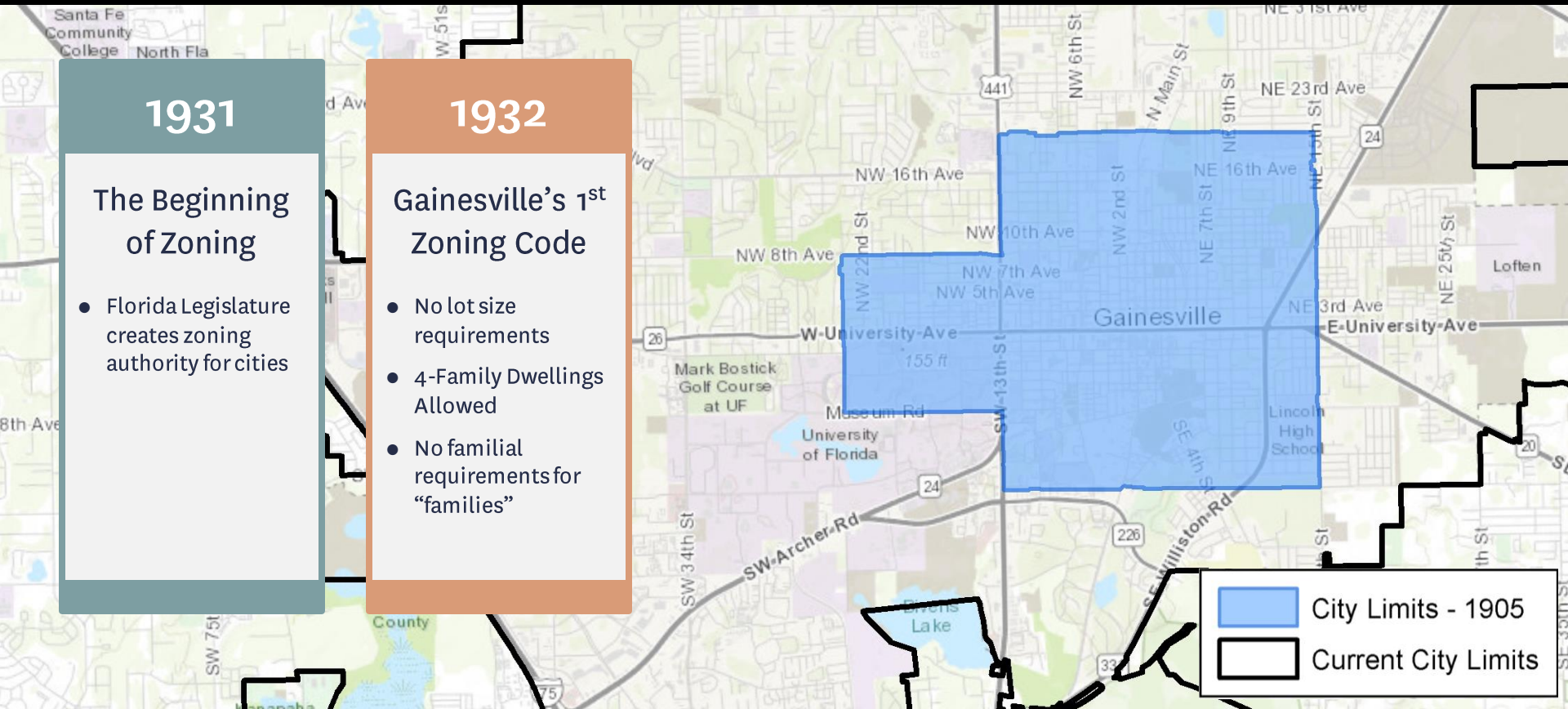

Gainesville City Limits – 1955

1949

Zoning Code Amendments

- Lot sizes introduced

1958

Major Zoning Code Changes

- Introduction of SF zoning district
- 4-Family Dwellings not allowed
- Family now defined by familial ties
- Minimum lot sizes expanded
- Minimum parking requirements introduced

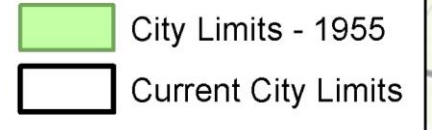

City Limits - 1955
 Current City Limits

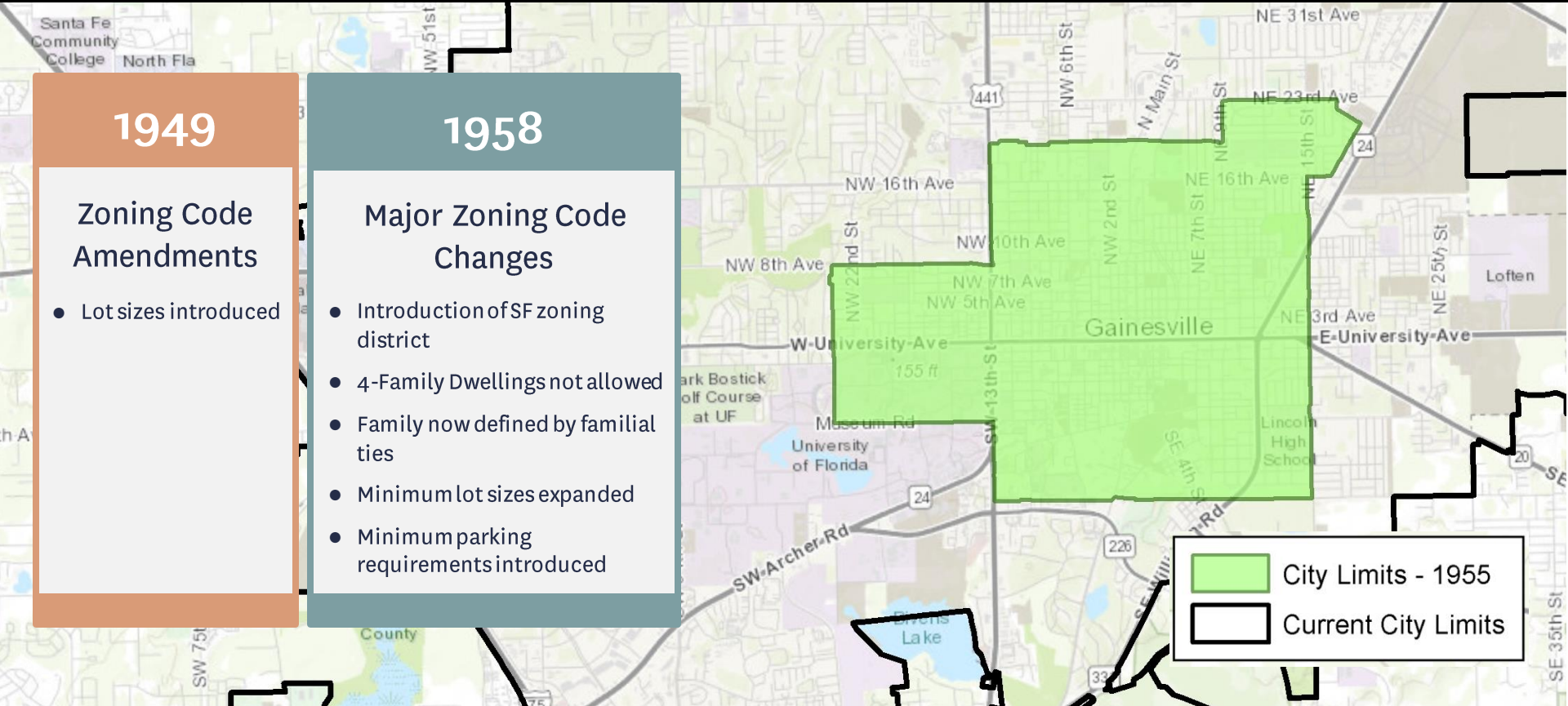

Gainesville City Limits – 1965

1966

Zoning Code Further Refined

- More exclusive single-family zoning districts
- Max residential density established
- Min. Lot Depth introduced
- Min. Parking increased
- Occupancy limits

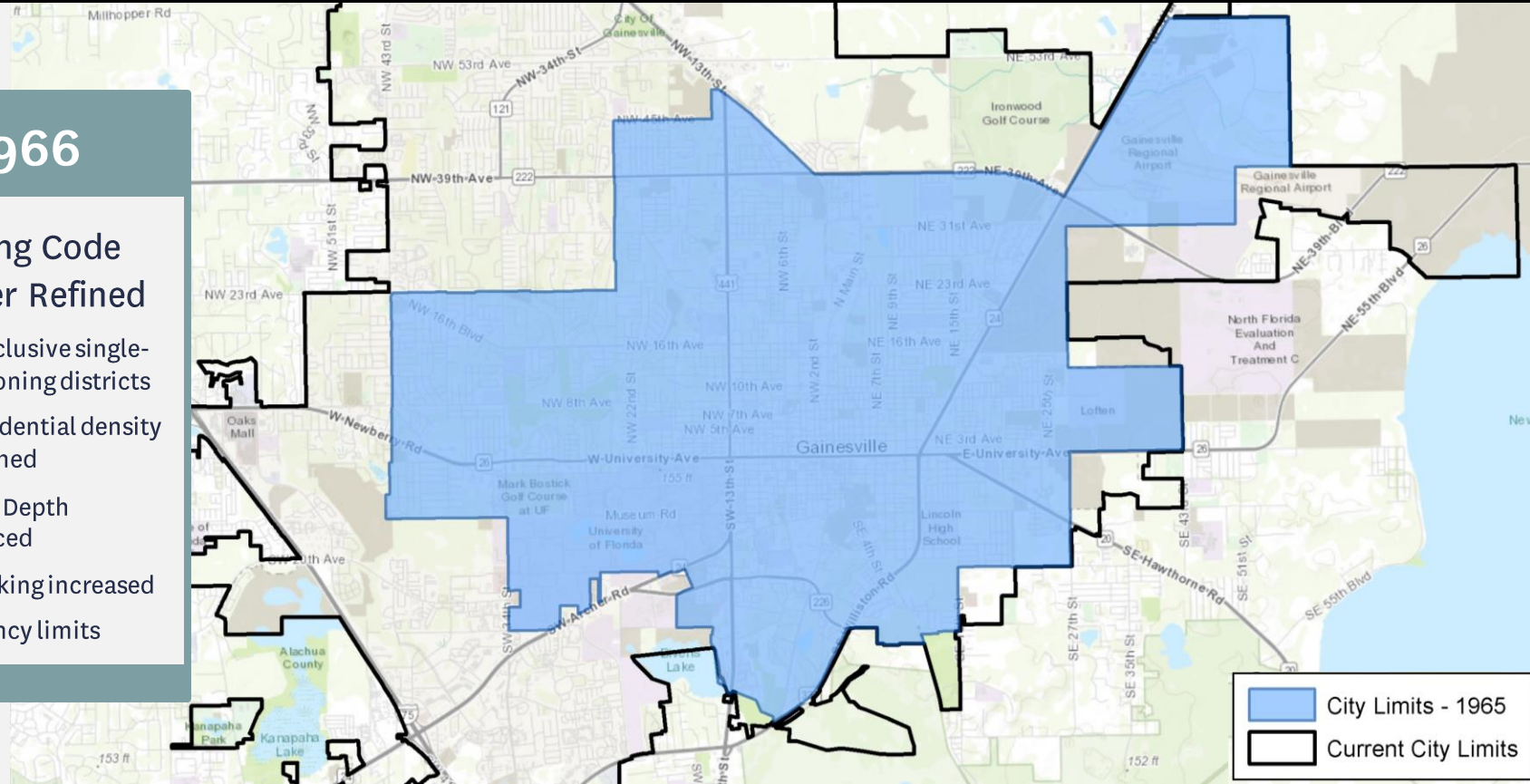

Gainesville City Limits – 1965

1990's - 2017

Multi-family boom

- Student apartment boom in the southwest
- New restrictions introduced on multifamily uses near SF zoning
- Densities near the University increase
- Growth of various special area plans

2018

Form Based Code

- Code update 2012-2017
- Transect zoning introduced
- Replaced Special Area Plans
- Zoning changes affect <5% of total City

2019 - Today

Affordable Housing Discussions

- ADU's introduced
- EZ actions
- No significant changes remain in the Land Development Code that address lot sizes.

1981

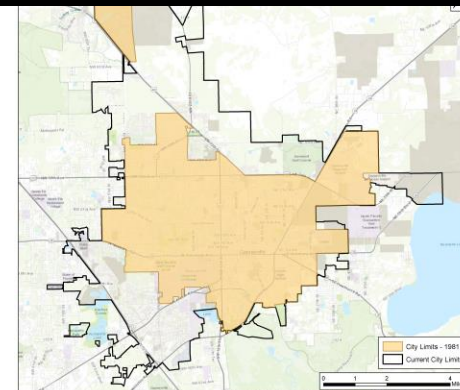

2010

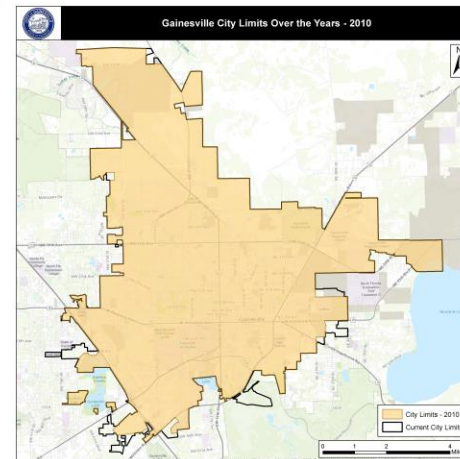

02

Housing Challenges

Gainesville is expected to grow to +/-189,000 by 2050. Affordable housing remains a top priority for the City.



“One of the most persistent factors depressing the supply of housing, especially entry-level and rental units, is exclusionary zoning laws and practices, like **minimum lot size requirements**, **minimum square footage requirements**, **unnecessary parking requirements**, **prohibitions on or differing treatment for multi-family homes**, **accessory dwelling units**, and **manufactured housing**, and **limits on the height of buildings.**”

— **Biden Administration
Housing Supply Proposal**

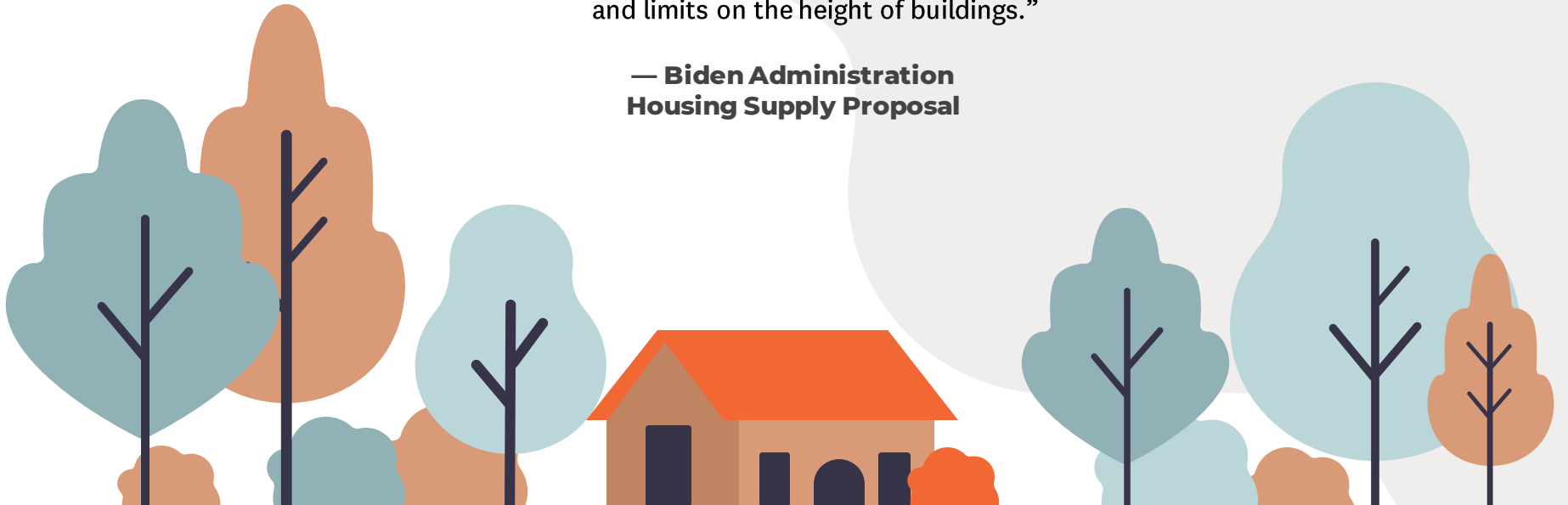

“While large minimum lot sizes are often defended on the basis of preserving neighborhood character or property values, their impact has been to perpetuate patterns of economic and demographic segregation of historically disadvantaged and vulnerable communities”

— **American Planning Association
(APA) Equity in Zoning Policy Guide**



Housing Challenges

2020

BLUEPRINT FOR
**AFFORDABLE
HOUSING**

AN ACTION PLAN
for the City of Gainesville

**FLORIDA
HOUSING
COALITION**

PREPARED BY:
The Florida Housing Coalition
September 2020

2021

City of
Gainesville

HR&A

Exclusionary Zoning & Inclusionary Zoning Study
Final Report
December 2021

Housing Challenges



CITY OF GAINESVILLE, FL

March 2022



Affordable Housing Framework for Discussion

MARCH 2022

OFFICE OF THE CITY MANAGER



CITY OF GAINESVILLE, FL

July 2022



Building Blocks for Affordable Housing Work Plan in Development

JULY 2022

OFFICE OF THE CITY MANAGER

03

Lot Size Reform

One housing tool that can impact the availability and affordability of single-family housing in particular is the reduction of minimum lot sizes.



Proposed Solutions – Amend Land Use Policies

Benefits of Changing Land Use Policies:

- No public funding needed to induce private development
- Increases the overall supply of housing
- Supports economic growth and expands the City's tax base

Without reducing restrictive land use practices, other housing strategies, and those that require subsidy in particular, are less effective and more costly.

Identified changes to land use strategies should be used in combination with **a set of housing tools** to address the housing needs of low- and very low-income Gainesville residents, who have the highest housing need.



Description of Request

Text Change

Land Development Code text change to create SF zoning district and lot standards

Comprehensive Plan Amendment

Changing the SF Future Land Use Category to align with new SF zoning

Zoning Map Change

RSF-1, RSF-2, RSF-3, and RSF-4 zoned properties -> new SF zoning with new lot standards



New SF Zoning allowing smaller Lots



One SF Zoning

RSF-1 through RSF-4
Single-Family Zoning
combined into SF Zoning*

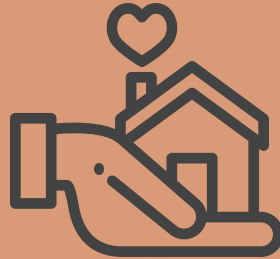

Small Lot Sizes

New SF Zoning allows the
creation of smaller lots
(35ft wide minimum,
3000 sq ft area)



Setback Changes

Adjusting setbacks to
alleviate minimum distance
from property lines

*No changes to permitted uses; single-family still allowed. Does not allow multi-family.

Reduced Lot Size Requirements

Sec. 30-4.17. Dimensional standards

The following tables contain the dimensional standards for the various uses allowed in each district:

Table V-5: Residential Districts Dimensional Standards.

	RSF-1	RSF-2	RSF-3	RSF-4	SE	RC
LOT STANDARDS						
Min. lot area (sq.ft.)	8,500	7,500	6,000	4,300	3,000	3,000
Min. lot width (ft.)						
Single-Family	85	75	60	50	35	35
Two-Family	NA	NA	NA	NA	NA	70
Other uses	85	75	60	50	NA	35
Min. lot depth	90	90	90	80	None	None



Small Lot Sizes
 New SF Zoning allows the creation of smaller lots (35ft wide minimum)

Text & Zoning Change: Combining Single-Family Zoning (SF)

Sec. 30-4.17. Dimensional standards

The following tables contain the dimensional standards for the various uses allowed in each district:

Table V-5: Residential Districts Dimensional Standards.

	RSF-1	RSF-2	RSF-3	RSF-4	SE	RC
DENSITY/INTENSITY						
Residential Density (Units/Acre)						
Min.	None	None	None	None	None	None
Max.	3-5	4-6	5-8	8	12	12
With density bonus points	-	-	-	-	=	-
Nonresidential building coverage	35%	35%	40%	40%	50%	50%



One SF Zoning

RSF-1 through RSF-4
Single-Family Zoning
combined into SF Zoning*

Setback Changes

Sec. 30-4.17. Dimensional standards

The following tables contain the dimensional standards for the various uses allowed in each district:

Table V-5: Residential Districts Dimensional Standards.

	RSF-1	RSF-2	RSF-3	RSF-4	SE	RC
MIN. SETBACKS (ft.)						
Front	20 ⁴	20 ⁴	20 ⁴	20 ⁴	10 ^{4,5}	10 ⁵
Side (street)	10	10	7.5	5	5	NA
Side (interior)	7.5	7.5	7.5	5	5	5
Rear	20	20	15	10	20	20
Rear (accessory)	7.5	7.5	5	5	5	5

4 = Lots abutting a collector or arterial street shall have a minimum depth of 150 feet and a minimum building setback of 50 feet along that street.



Existing Standards – Lot Sizes

RSF-1

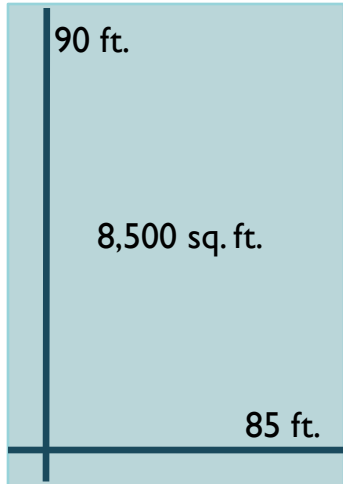

Min. Lot Area: 8,500 Sq. Ft.
 Min. Lot Width: 85 Ft.
 Min. Lot Depth: 90 Ft.

RSF-2

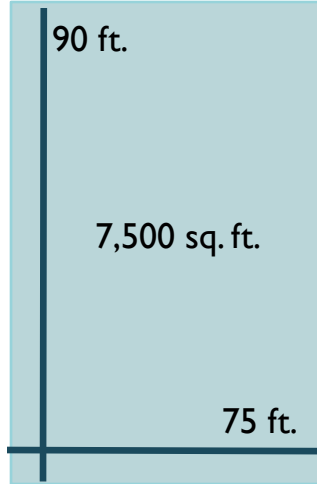

Min. Lot Area: 7,500 Sq. Ft.
 Min. Lot Width: 75 Ft.
 Min. Lot Depth: 90 Ft.

RSF-3



Min. Lot Area: 6,000 Sq. Ft.
 Min. Lot Width: 60 Ft.
 Min. Lot Depth: 90 Ft.

RSF-4

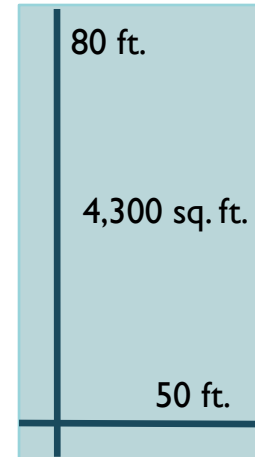

Min. Lot Area: 4,300 Sq. Ft.
 Min. Lot Width: 50 Ft.
 Min. Lot Depth: 80 Ft.

RC

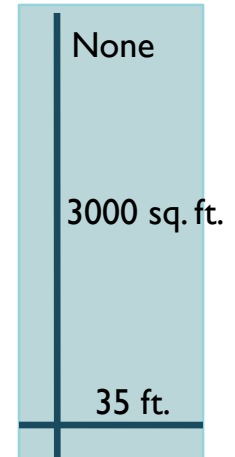

Min. Lot Area: 3,000 Sq. Ft.
 Min. Lot Width: 35 Ft.
 Min. Lot Width (two family):
 70 Ft.
 Min. Lot Depth: None

Proposed Standards – Lot Sizes

SF

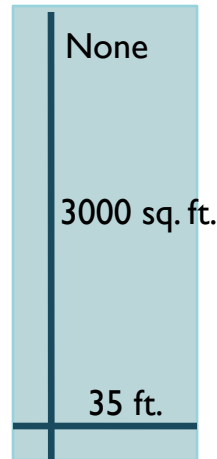

Min. Lot Area: 3,000 Sq. Ft.
Min. Lot Width: 35 Ft.
Min. Lot Depth: None

RC

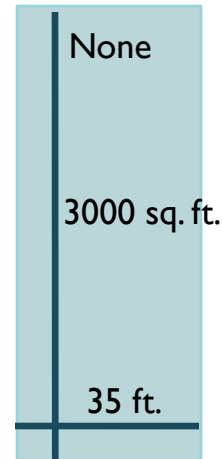

Min. Lot Area: 3,000 Sq. Ft.
Min. Lot Width: 35 Ft.
Min. Lot Width (two family): 70 Ft.
Min. Lot Depth: None

Existing Standards – Setbacks

RSF-1

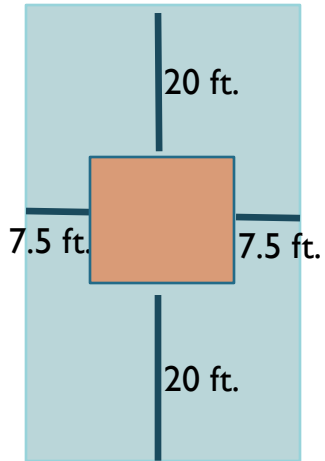

Front: 20 ft.
 Side (Street): 10 ft.
 Side (Interior) 7.5 ft.
 Rear: 20 ft.
 Rear accessory: 7.5 ft.

RSF-2

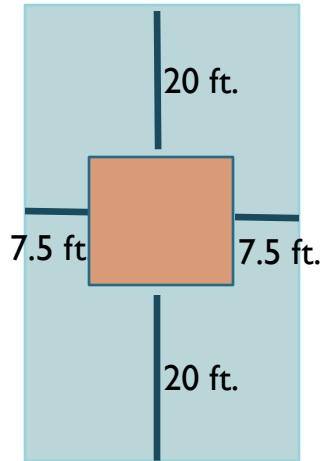

Front: 20 ft.
 Side (Street): 10 ft.
 Side (Interior) 7.5 ft.
 Rear: 20 ft.
 Rear accessory: 7.5 ft.

RSF-3

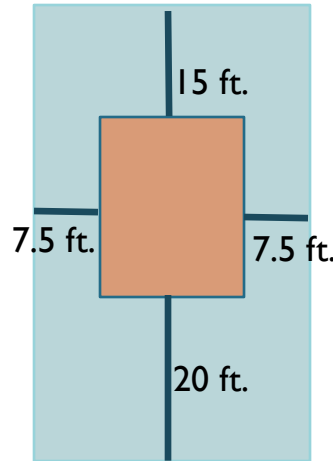

Front: 20 ft.
 Side (Street): 7.5 ft.
 Side (Interior) 7.5 ft.
 Rear: 15 ft.
 Rear accessory: 5 ft.

RSF-4

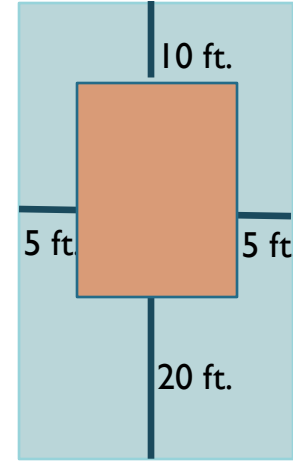

Front: 20 ft.
 Side (Street): 5 ft.
 Side (Interior) 5 ft.
 Rear: 10 ft.
 Rear accessory: 5 ft.

RC

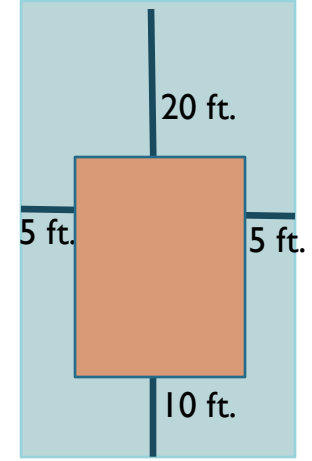

Front: 10 ft.
 Side (Street): NA
 Side (Interior) 5 ft.
 Rear: 20 ft.
 Rear accessory: 5 ft.

Proposed Standards – Setbacks

SF

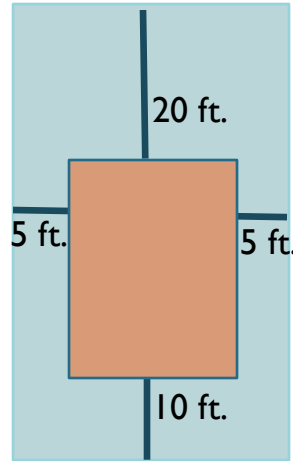

Front: 10 ft.
Side (Street): NA
Side (Interior) 5 ft.
Rear: 20 ft.
Rear accessory: 5 ft.

RC

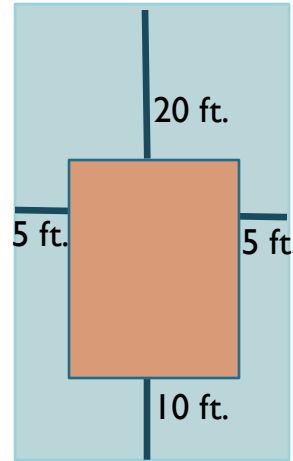

Front: 10 ft.
Side (Street): NA
Side (Interior) 5 ft.
Rear: 20 ft.
Rear accessory: 5 ft.

Zoning Map Amendment

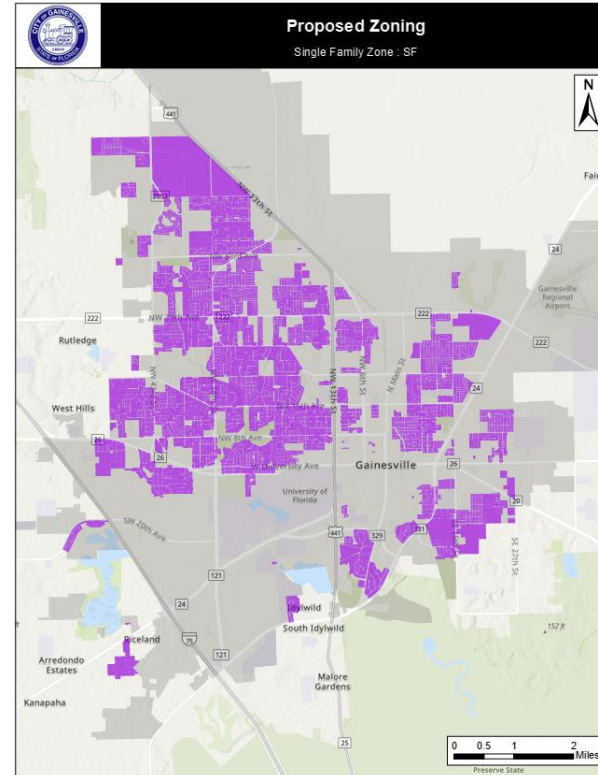
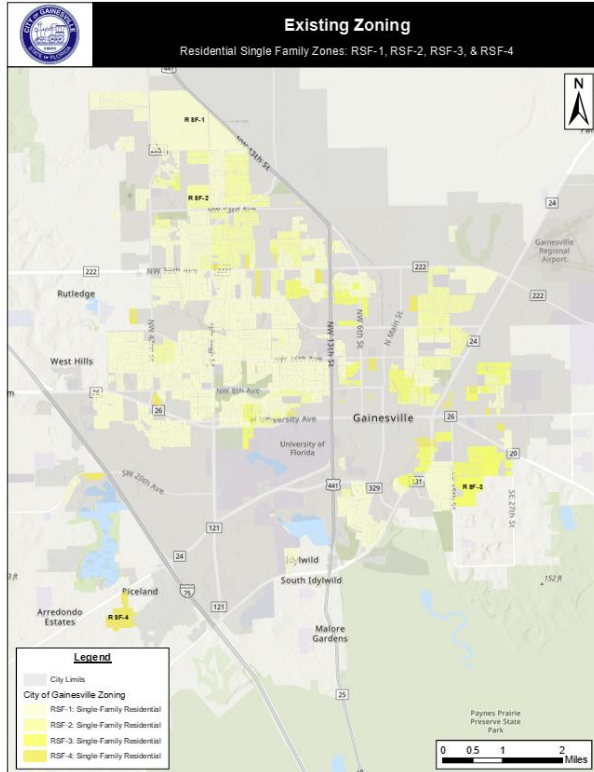

Rezoning RSF-1, RSF-2, RSF-3, and RSF-4 to SF

Minor Subdivision Standards



Proposed changes to
Sec. 30-3.36. Minor subdivisions



Allows for homes within minor subdivisions to be built around a centrally-located common greenspace.



In this configuration, individual owners are provided legal rights to ingress and egress to a public street or an approved private street.

Comprehensive Plan Amendment

Policy 4.1.1 Land Use Categories on the Future Land Use Map shall be defined as follows:

Existing Text

Single-Family (SF): up to 8 units per acre

This land use category shall allow single-family detached dwellings at densities up to 8 units per acre. The Single-Family land use category identifies those areas within the City that, due to topography, soil conditions, surrounding land uses and development patterns, are appropriate for single-family development...

Proposed Text

Single-Family (SF): up to 12 units per acre

This land use category shall allow single-family detached dwellings at densities up to 12 units per acre. The Single-Family land use category identifies those areas within the City that, due to topography, soil conditions, surrounding land uses and development patterns, are appropriate for single-family development...

04

Data and Analysis

Applicability of changes, map of affected properties and housing examples



Applicability of Changes

Proposed changes would impact properties with RSF-1, RSF-2, RSF-3, or RSF-4 zoning

RSF zoning = +/-8,434 acres (+/-21.5%) of land area in the city

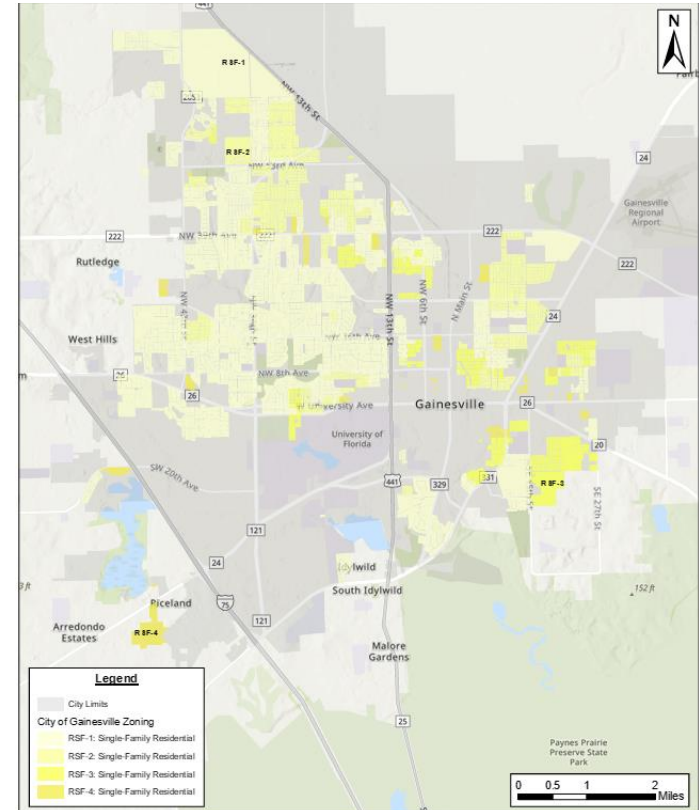

Map of Affected Vacant Parcels

Residential properties with RSF-1, RSF-2, RSF-3, or RSF-4 zoning

Vacant

70ft frontage or greater

7000 sf in lot area

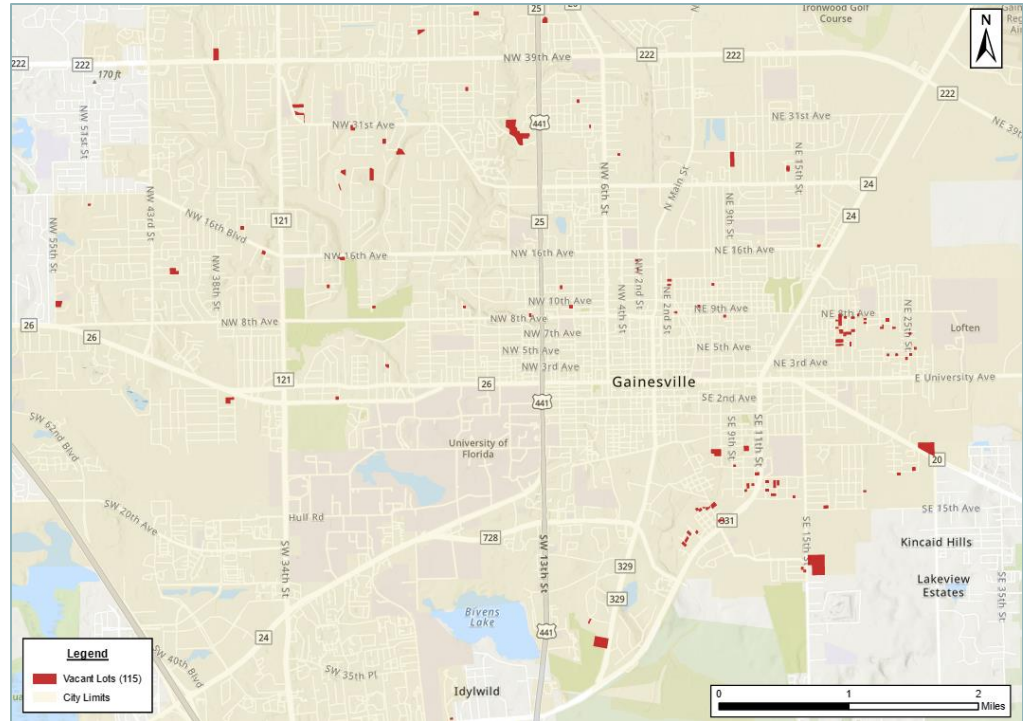

Lot Dimensions Standards

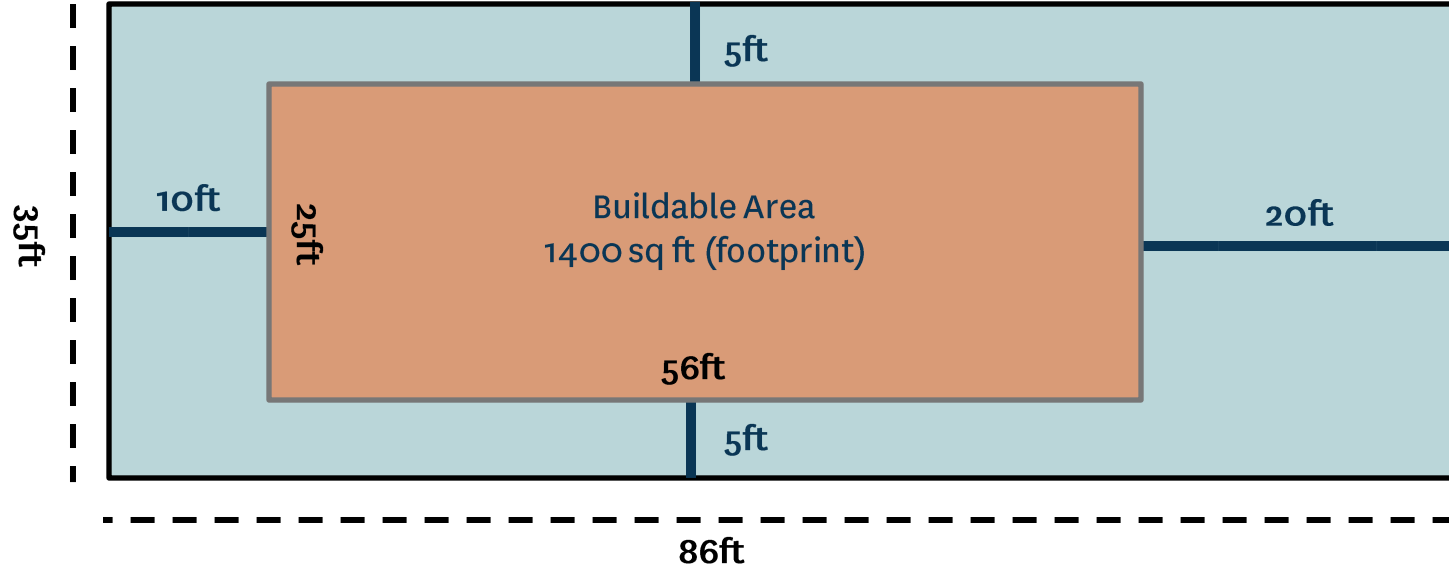

Zoning	Units/Acre	Min. Lot Size	Lot Frontage	Front Setback	Side Setback (Interior)	Setback (street side)	Rear Setback
SF	12	3,000 sq ft	35 ft	10 ft	5 ft	5 ft	20 ft



2024-263B

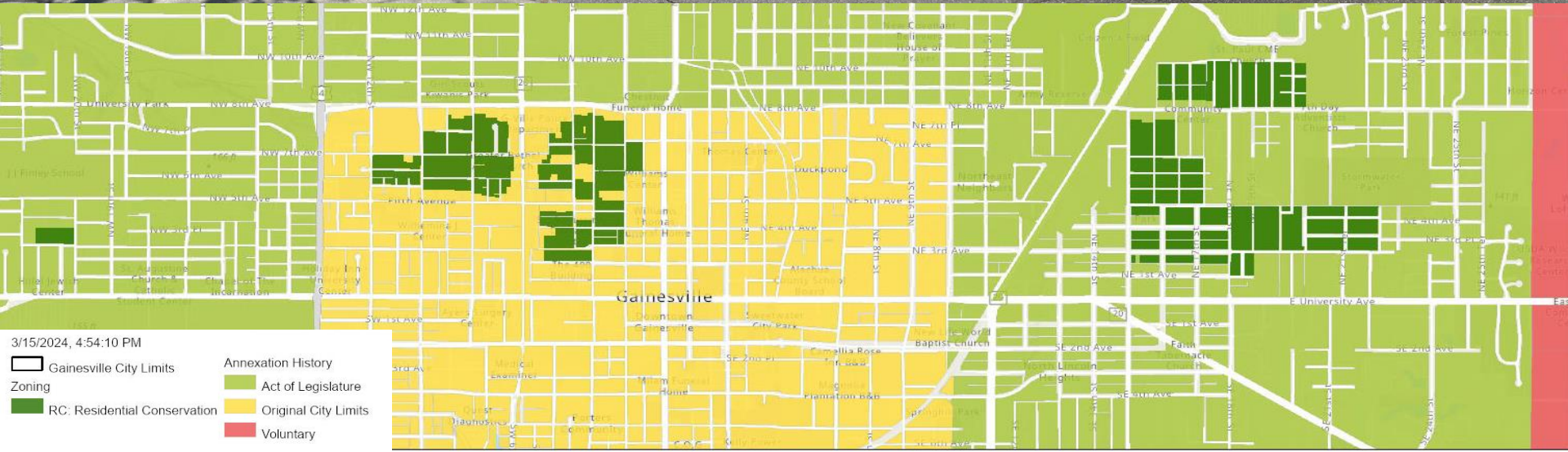

3/15/2024, 4:54:10 PM

□ Gainesville City Limits

□ Zoning

■ RC: Residential Conservation

Annexation History

■ Act of Legislature

■ Original City Limits

■ Voluntary

Case Studies – Minimum Lot Size Changes

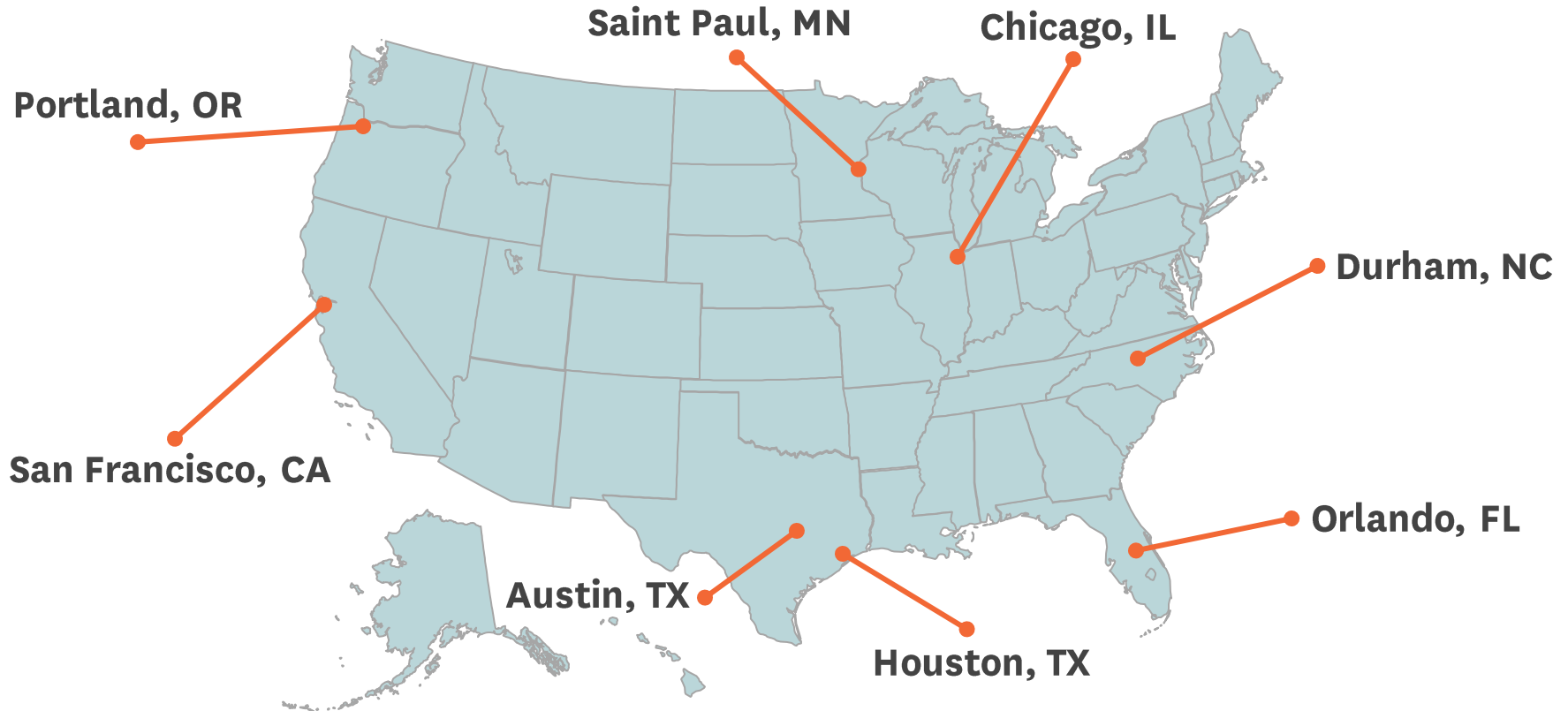

Comprehensive Plan Consistency

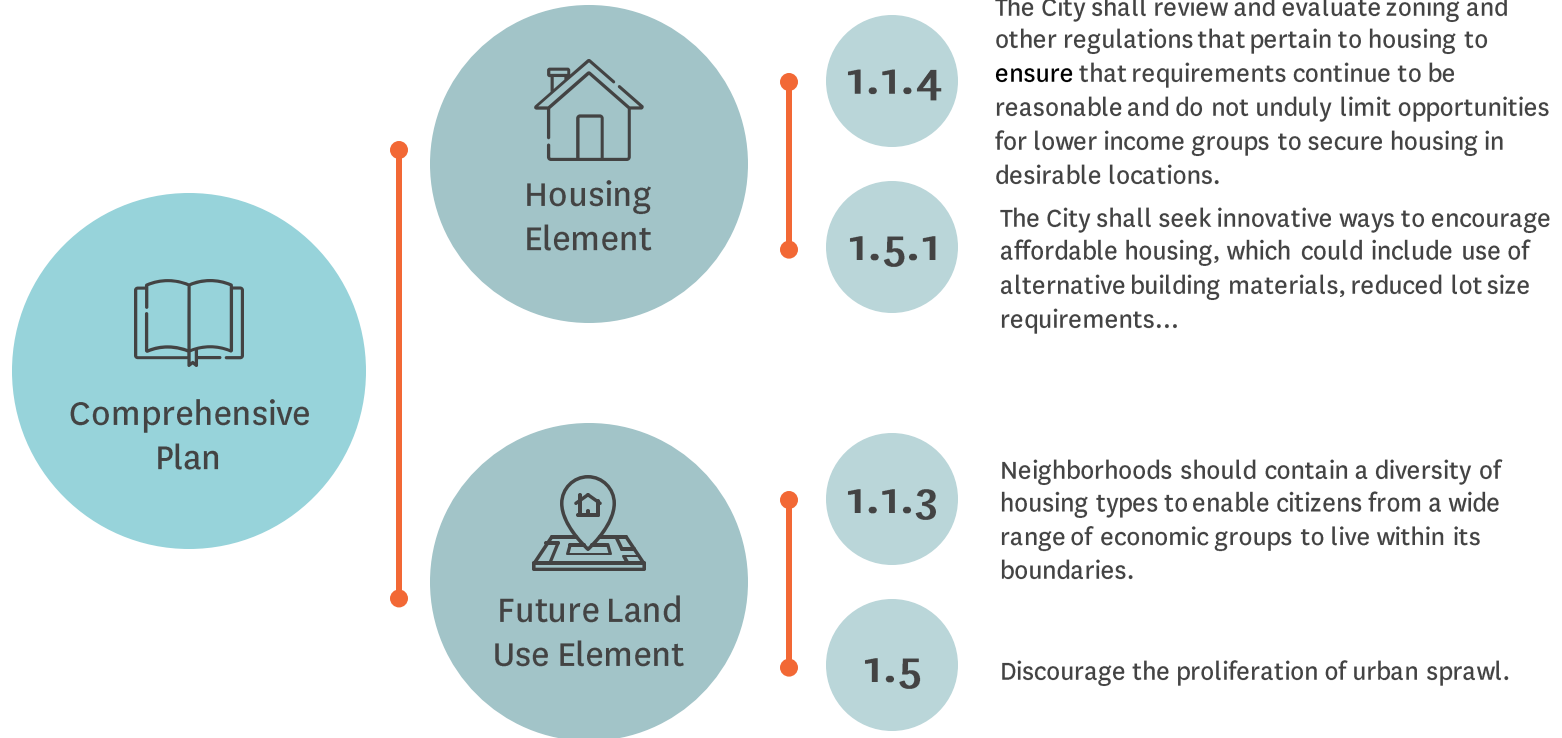

05

Public Participation

2 neighborhood/community workshops
held about this proposal



2 Workshops



MLK Multipurpose Center

- October 30th, 2023, 6pm – 7:30pm



Albert “Ray” Massey Recreation Center

- November 15th, 2023, 6pm – 7:30pm

Summary of Feedback:

- Questions and concerns about neighborhood protection, infrastructure capacity, and housing affordability
- Applicability of the change on neighborhoods with restrictive covenants
- As the City grows, having more housing options within the City benefits more people



Summary

Proposed change

- Retains single-family zoning (consolidates into one SF zoning district)
- Maintains setbacks between homes
- Reduces minimum lot size to 35-ft wide, 3,000 sq ft
- Allows for homes within minor subdivisions to be built around a centrally-located common greenspace

Benefits

- Increases flexibility for single-family development
- Provides for more diverse housing options
- Gives flexibility to small-scale builders



06

Conclusion

Affordable housing remains a top priority for the City, and amending lot sizes to allow for flexibility for new single-family home development is one way to address future housing needs.



Conclusion: Reducing lot sizes is...

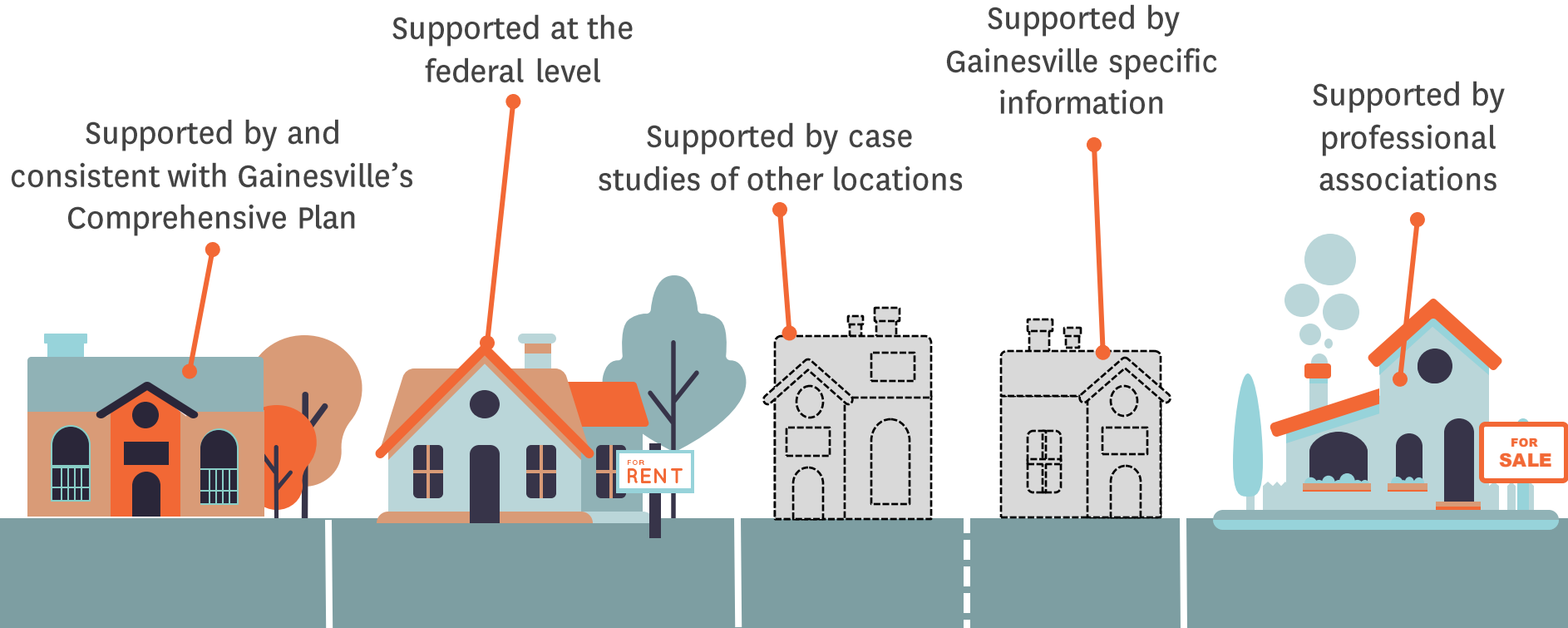

Proposal Timeline

2023 Small Lot Proposal Workshops

City held several workshops explaining the rationale of the proposal and received input from the community



Staff Review and Analysis

Staff reviewed the proposal, synthesized available data, and created an analysis based on the City Commission's direction



Jan 11th, 2024 City Commission Motion

The City Commission directed staff to review the proposal with related data and analysis

TBD City Commission Meeting

The small lot proposal is routed to the City Attorney's Office to draft an ordinance which will subsequently be reviewed by the City Commission



Mar 28th, 2024 City Plan Board Meeting

Staff presents the small lot proposal and related data and analysis to the City Plan Board

Recommendation:

Staff: Approve

**City Plan Board: Approve with one modification to
Petition LD24-000032**



Recommendation:

City Plan Board: Approve with one modification
Require a 10-ft setback instead of 20-ft

	RSF-1	RSF-2	RSF-3	RSF-4	SE	RC
MIN. SETBACKS (ft.)						
Front	20 ⁴	20 ⁴	20 ⁴	20 ⁴	10 ^{4,5}	10 ⁵
Side (street)	10	10	7.5	5	5	NA
Side (interior)	7.5	7.5	7.5	5	5	5
Rear	20	20	15	10	10	20
Rear (accessory)	7.5	7.5	5	5	5	5

